

### Extrusion

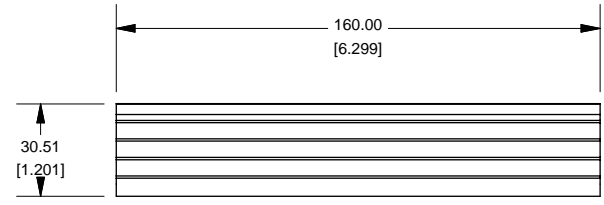

EXTRUSION DESIGNED FOR 100MM WIDE PC BOARD

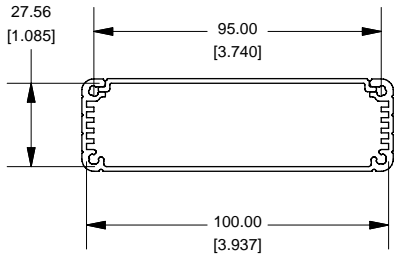
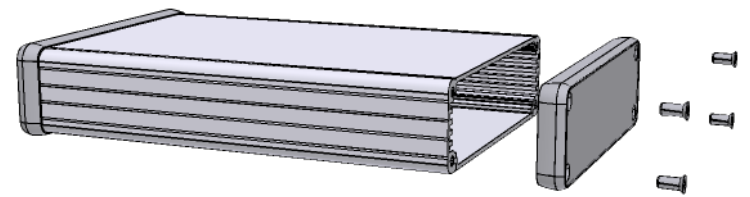

### Slot Details

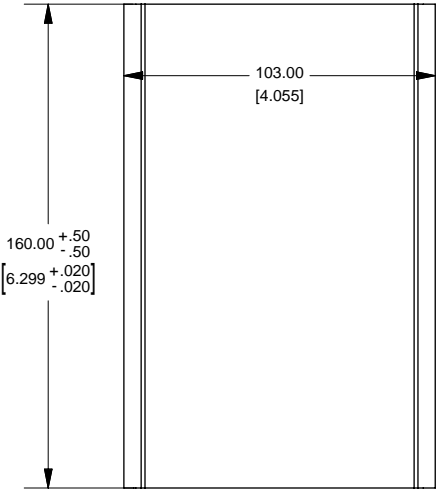
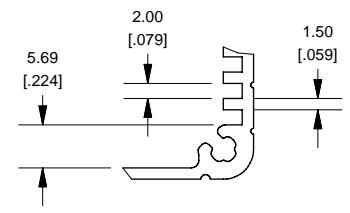

### Closed Bezel

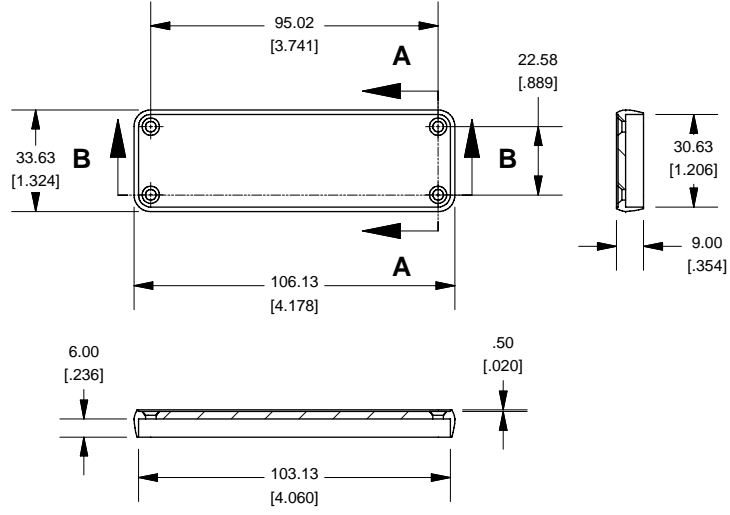

Enclosures can be Factory Modified ( Milling, Drilling, Printing etc. )  
 Solid models of this enclosure available in STEP or IGES.  
 Contact Factory [mjm@hammondmfg.com](mailto:mjm@hammondmfg.com)

NOTE	
Purchased assembly includes box, plastic bezels, #6 Taptight screws and self adhesive rubber feet.	
Box made from Extruded Aluminum 6063.	
Bezels made with ABS.	

1455L1602	
PART NUMBERS	
Clear Anodized	1455L1602
Black Anodized	1455L1602BK
ACCESSORIES	
See website for accessories.	

**HAMMOND MANUFACTURING™**  
**1455L1602**  
[www.hammondmfg.com](http://www.hammondmfg.com)